

PRELIMINARY DATASHEET

CGY2179HV/C1

4-bit Ku-Band Core Chip

DESCRIPTION

The CGY2179HV/C1 is a high performance QFN packaged T/R 4-bit Core Chip operating in Ku-band. It includes a 4-bit phase shifter and an LNA. It has a phase shifting range of 360°, and a LSB of 22.5°. It covers the frequency range from 10.7 to 12.75 GHz and can be used in Telecommunication, Radar, Antennas, and Instrumentation applications.

The on-chip control logic with serial input register minimizes the number of bonding pads and greatly simplifies the interfacing to this device.

This die is manufactured using OMMIC's 0.18 μm gate length PHEMT Technology. The MMIC uses gold bonding pads and backside metallization and is fully protected with Silicon Nitride passivation to obtain the highest level of reliability. This technology has been evaluated for Space applications and is on the European Preferred Parts List of the European Space Agency.

APPLICATIONS

- ▶ Radar, Antennas
- ▶ Telecommunication
- ▶ Instrumentation



FEATURES

- ▶ Operating Range : 10.7 GHz to 12.75 GHz
- ▶ RF Gain \approx 12 dB at 11.7 GHz (all states)
- ▶ NF \approx 1.9 dB at 11.7 GHz (all states)
- ▶ RMS Phase Error \approx 7° @ 11.7 GHz
- ▶ RMS Amplitude Error \approx 0.6 dB @ 11.7 GHz
- ▶ Output P1dB \approx +3 dBm
- ▶ $S_{11} \approx$ -15 dB at 11.7 GHz (all states)
- ▶ $S_{22} \approx$ -12 dB at 11.7 GHz (all states)
- ▶ Total Power Consumption \approx 200 mW
- ▶ Package Dimensions = 4 x 5 mm²
- ▶ Delivered as 100% RF tested devices
- ▶ Samples and Demo Board Available

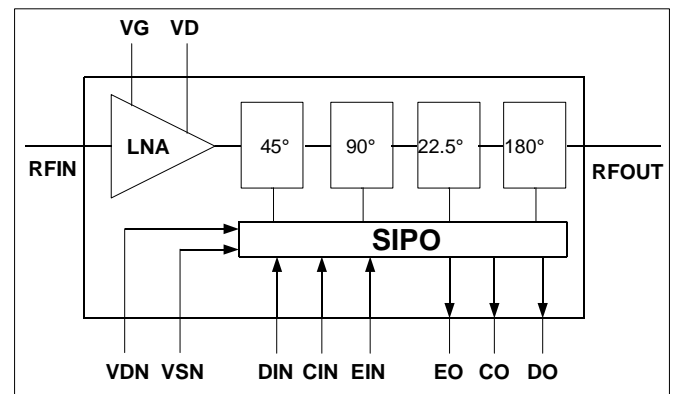

Block Diagram of the CGY2179HV

LIMITING VALUES

$T_{amb} = 25\text{ °C}$ unless otherwise noted

Symbol	Parameter	Conditions	MIN.	MAX.	UNIT
V_{DN}	Positive supply voltage		-1	+6	V
V_{SN}	Negative supply voltage		-6	+1	V
D_{IN} , CLK and LE	Digital data input		-1	+6	V
V_D	Drain voltage		-1	+3	V
V_G	Gate voltage		-0.4	0	V
P_{IN}	Input power			0	dBm
T_j	Junction temperature			+150	°C
T_{stg}	Storage temperature		-55	+150	°C

OPERATING CONDITIONS

$T_{amb} = 25\text{ °C}$ unless otherwise noted

Symbol	Parameter	Conditions	MIN.	MAX.	UNIT
V_{DN}	Positive supply voltage		0	+5	V
V_{SN}	Negative supply voltage		-5	0	V
D_{IN} , CLK and LE	Digital data input		0	+5	V
V_D	Drain voltage		0	+2	V
V_G	Gate voltage		-0.4	0	V
P_{IN}	Input power			0	dBm
T_{amb}	Ambient temperature		-40	+85	°C

THERMAL CHARACTERISTICS

Symbol	Parameter	Value	UNIT
$R_{th(j-a)}$	Thermal resistance from junction to ambient ($T_a = 25\text{ °C}$)	TBD	°C/W

CHARACTERISTICS

RF performance are measured on board at T = 25 °C. Typical RF Performance are given at 11.7 GHz, for the nominal biasing conditions : V_D = +2 V and V_G = -0.3 V.

Symbol	Parameter	Conditions	MIN.	TYP.	MAX.	UNIT
<i>DC Supplies</i>						
V _{DN}	Positive supply voltage		4.5	5	5.5	V
I _{DN}	Positive supply current			12		mA
V _{SN}	Negative supply voltage		-5.5	-5	-5.5	V
I _{SN}	Negative supply current			5		mA
V _D	Drain voltage		1.8	2	2.2	V
I _D	Drain current	V _G = -0.3 V		55		mA
<i>RF Performance at 11.7 GHz, V_D = +2V and V_G = -0.3V, unless otherwise specified</i>						
BW	Bandwidth		10.7		12.75	GHz
G	RF Gain		10	12		dB
NF	Noise Figure at reference state			1.9		dB
S ₁₁	Input reflection coefficients (all states)			-15		dB
S ₂₂	Output reflection coefficients (all states)			-12		dB
PH _{Range}	Phase range			+360		°
PH _{error (RMS)}	RMS Phase Error wrt the 16 Phase States			7		°
AMP _{var (RMS)}	RMS Gain Variation wrt the 16 Phase States			0.6		dB
P _{1dB}	Output 1dB compression point			+3		dBm
Rate	Serial data rate			10		Mbps

Note : The RMS value is the root mean square of the error defined as below :

$$x_{RMS} = \sqrt{\frac{1}{N} \sum_{i=1}^N x_i^2} = \sqrt{\bar{x}_i^2 + \sigma_{x_i}^2}$$

Where x_i is the difference between the measured value and the theoretical value, \bar{x}_i is the mean value of the N x_i, and σ_{x_i} is the standard deviation of x_i.



Caution : This device is a high performance RF component and can be damaged by inappropriate handling. Standard ESD precautions should be followed. OMMIC document “OM-CI-MV/ 001/ PG” contains more information on the precautions to take.

ON BOARD MEASUREMENTS – S PARAMETERS

Measured at nominal power supply voltages and at T = 25 °C.

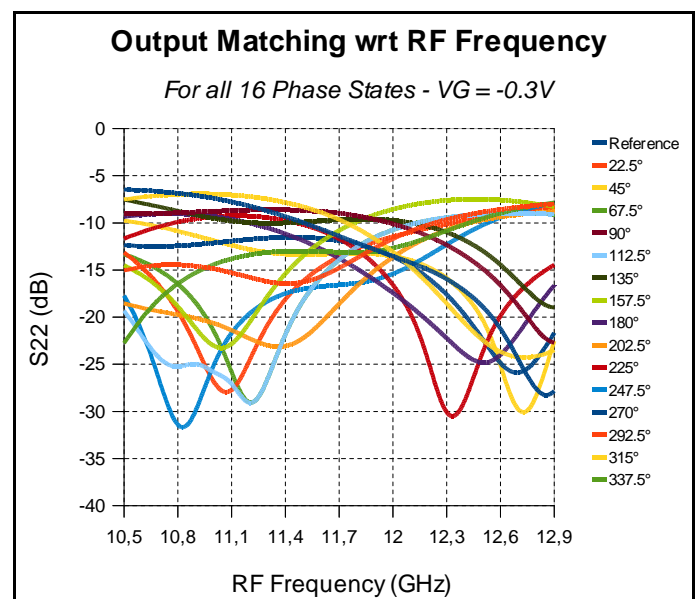
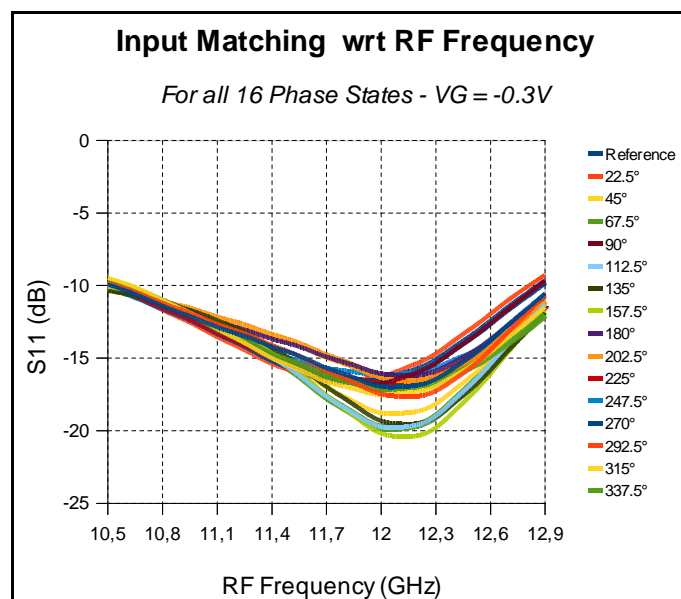
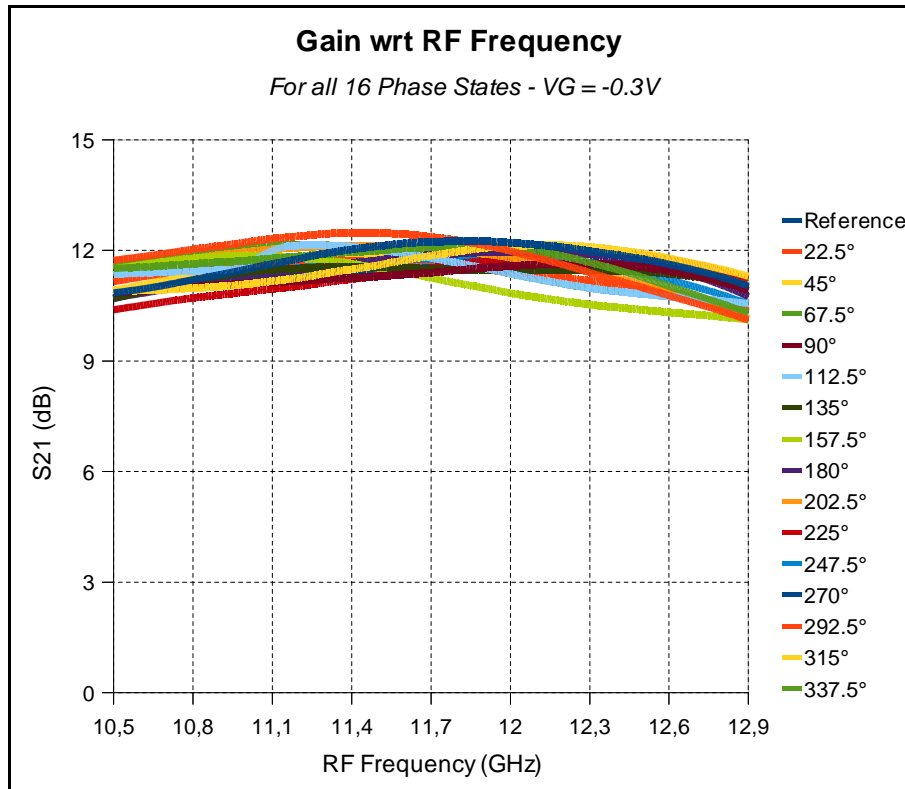

ON BOARD MEASUREMENTS – PHASE SHIFTER RESPONSE

Measured at nominal power supply voltages and at T = 25 °C.

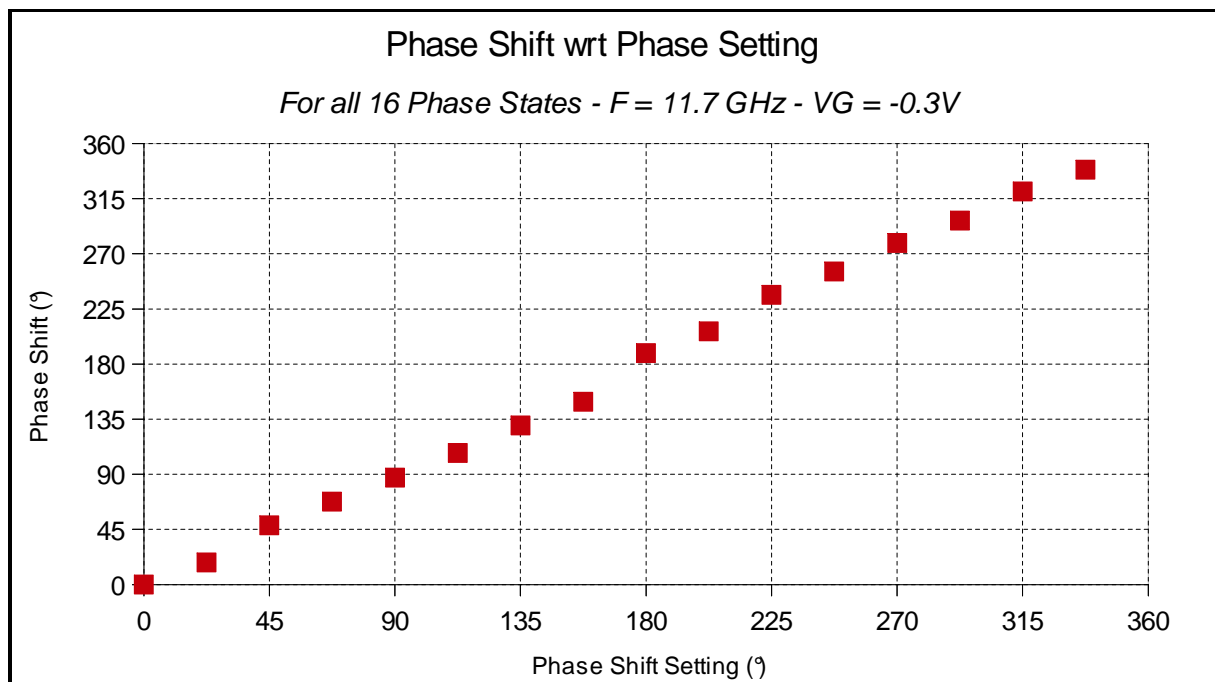
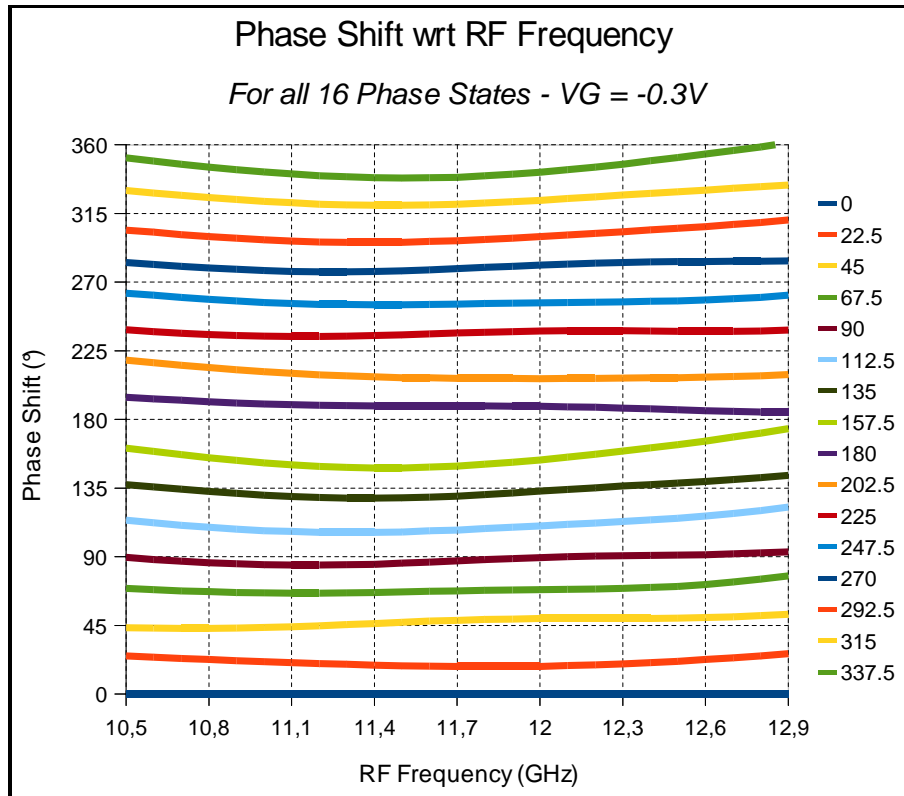

ON BOARD MEASUREMENTS – PHASE SHIFTER ERRORS

Measured at nominal power supply voltages and at T = 25 °C.

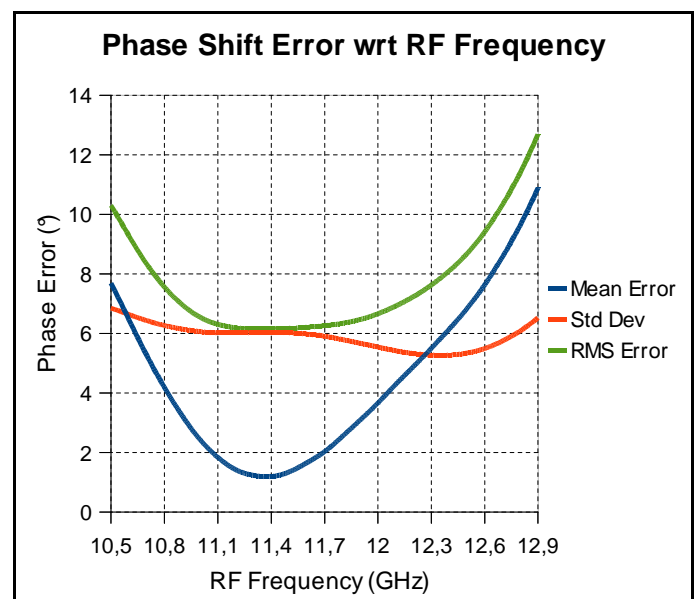
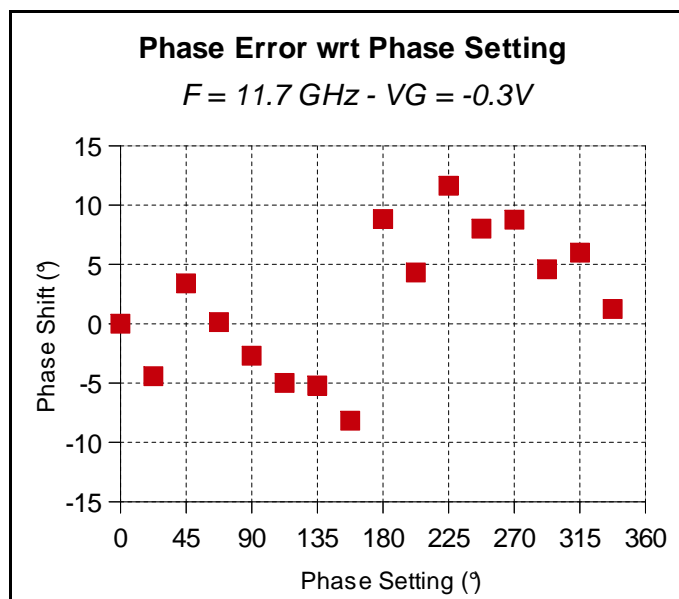
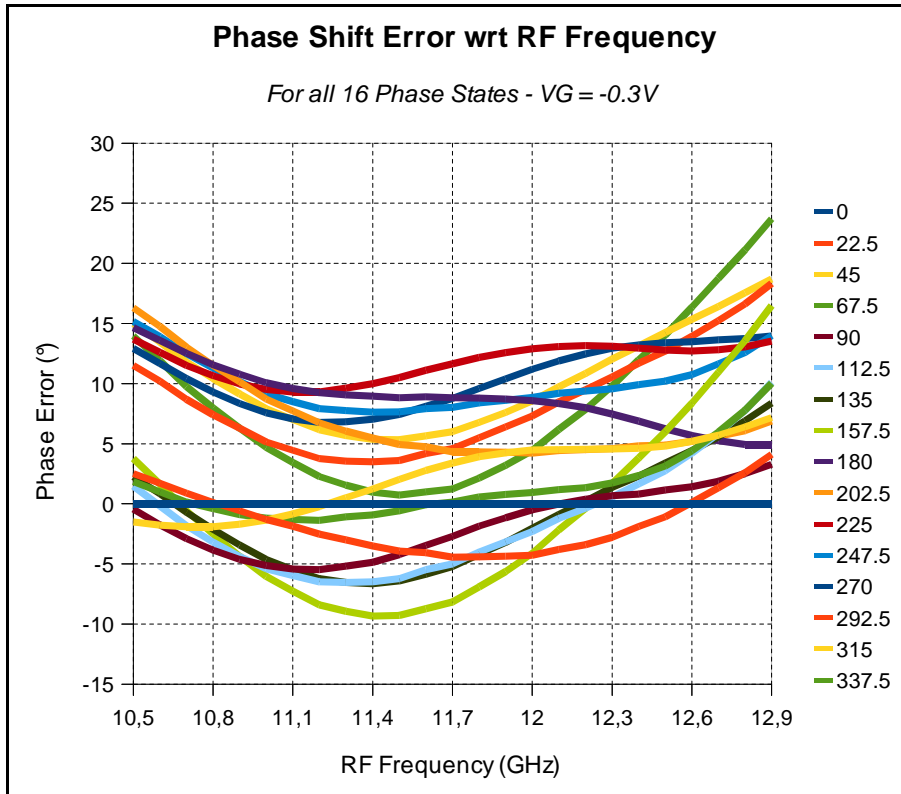

ON BOARD MEASUREMENTS – PHASE SHIFTER ERRORS

Measured at nominal power supply voltages and at T = 25 °C.

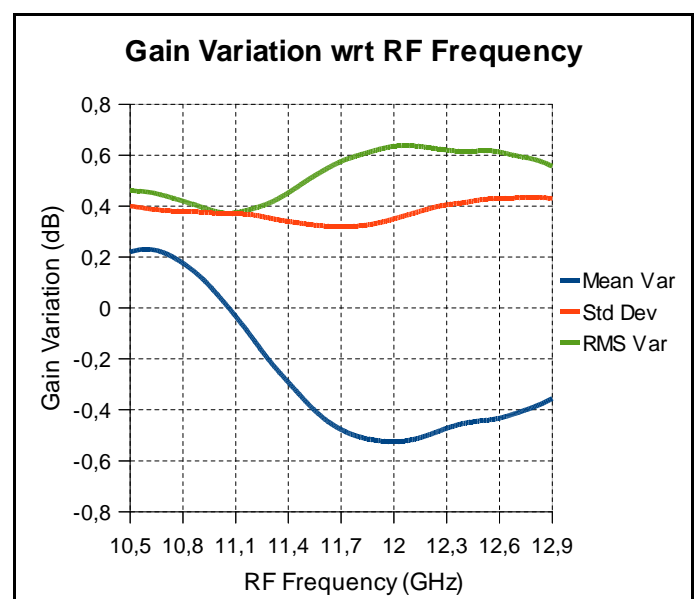
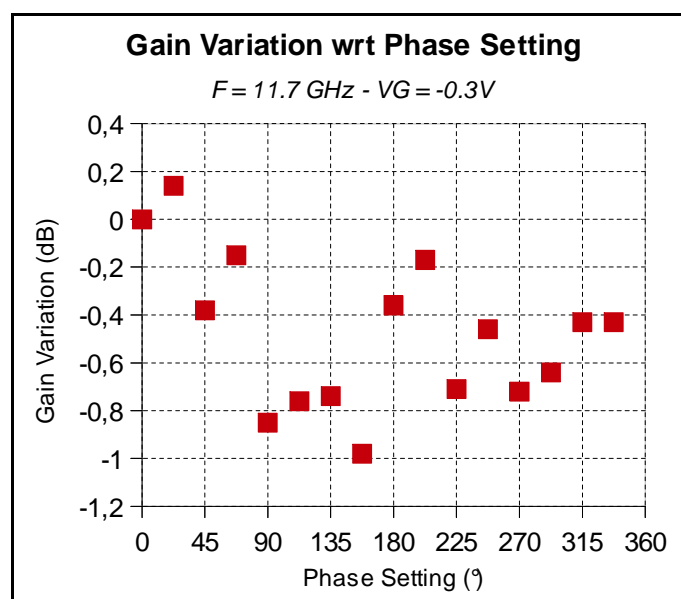
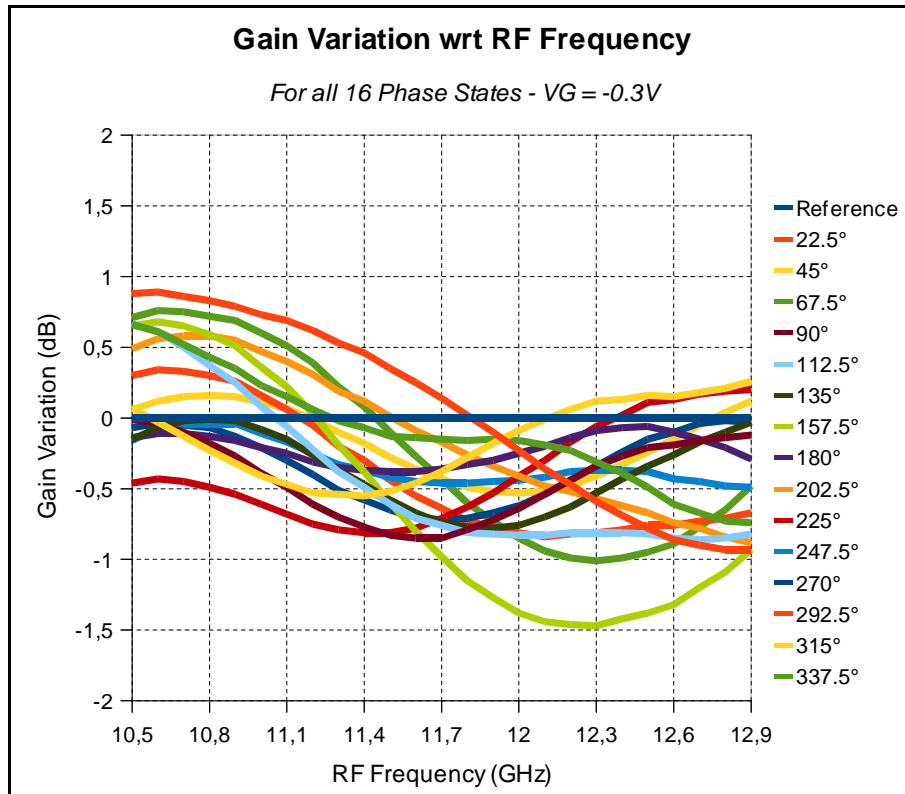

DATA

Bit Number	Description	Reference State	Theoretical Value
B0	Enable	Low	-
B1	45° Phase Shifting Cell	Low	45°
B2	90° Phase Shifting Cell	Low	90°
B3	22.5° Phase Shifting Cell	Low	22.5°
B4	180° Phase Shifting Cell	Low	180°

CONTROL VOLTAGE (CMOS STANDARD LOGIC)

State	Vmin	Vmax
Low	0 V	1 V
High	+3 V	V _{DN}

TIME DIAGRAM

- DIN is sampled at the falling edge of CIN.
- Falling edge of EIN must occur when all the 5 bits are loaded and on high level of CIN.
- DIN is transferred and Phase Shifter positions changed on high level of EIN.

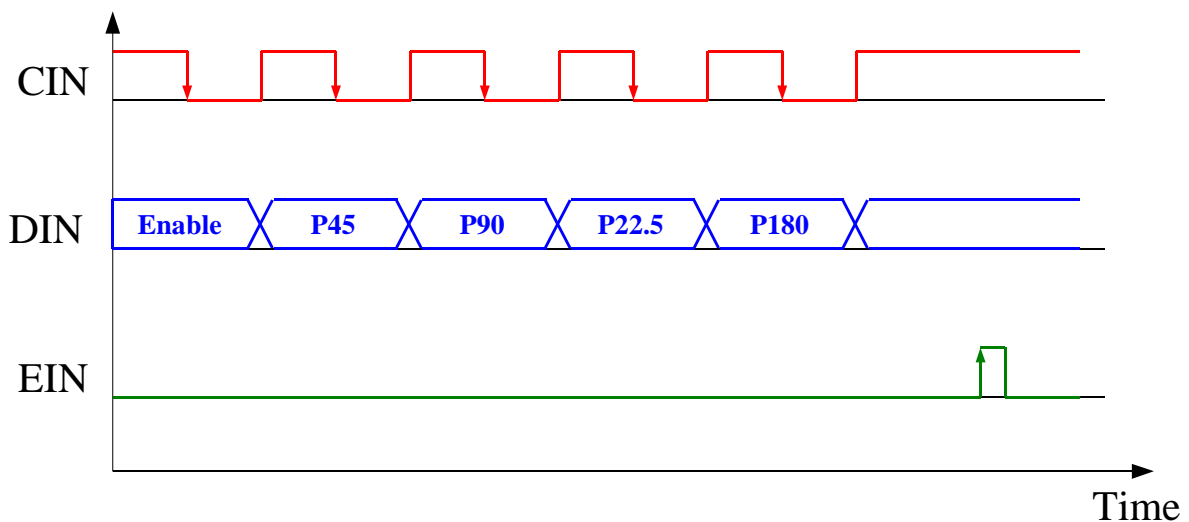

PIN CONFIGURATION

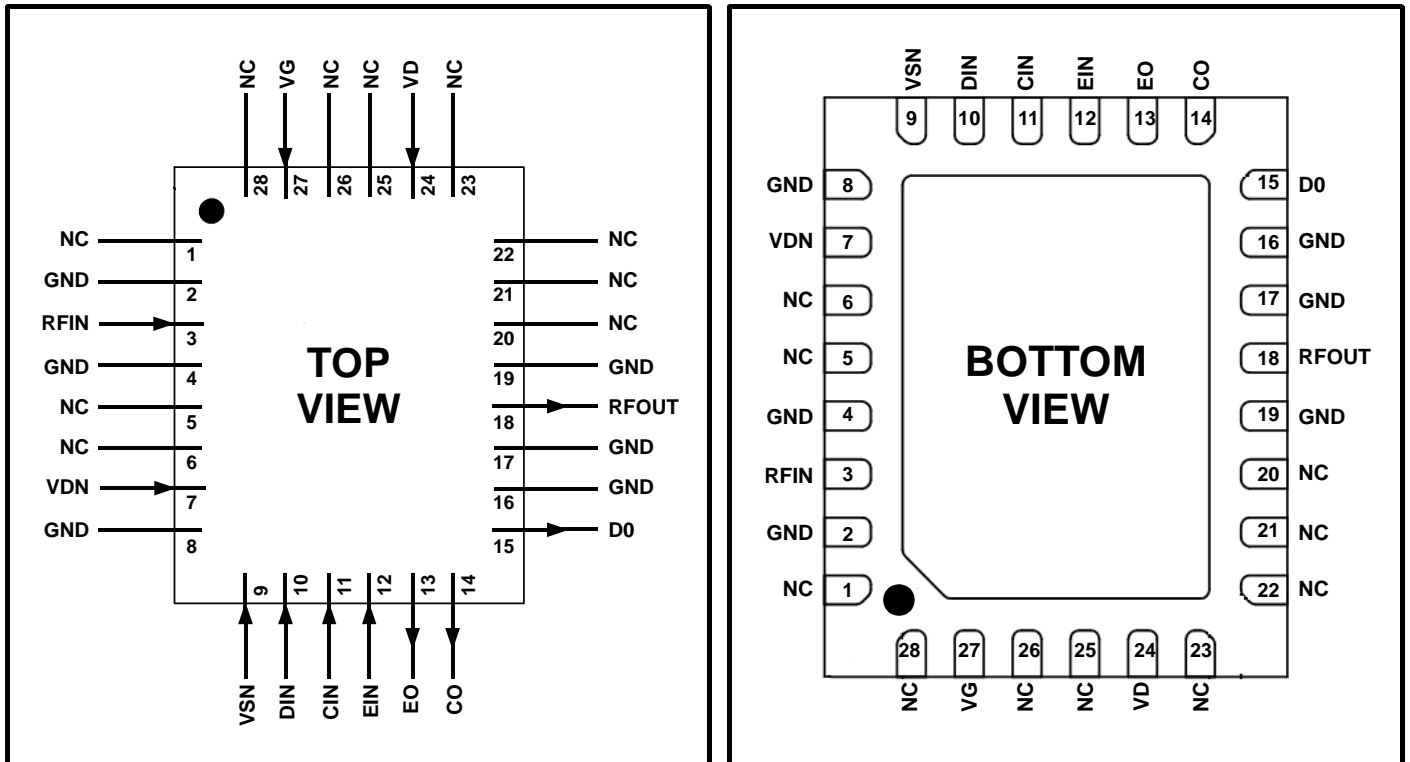

SYMBOL	PIN	DESCRIPTION
GND	2, 4, 8, 16, 17, 19	Ground
RFIN	3	RF Input
VDN	7	Positive Supply Voltage
VSN	9	Negative Supply Voltage
DIN	10	Data Input
CIN	11	Clock Input
EIN	12	Enable Input
EO	13	Data Output
CO	14	Clock Output
DO	15	Enable Output
RFOUT	18	RF Output
VD	24	Drain Voltage
VG	27	Gate Voltage
NC	1, 5, 6, 20, 21, 22, 23, 25, 26, 28	Not Connected

Note :

It is essential in order to ensure good performance and stability that the central ground pad of the QFN package is suitably connected to the ground.



Caution : This device is a high performance RF component and can be damaged by inappropriate handling. Standard ESD precautions should be followed. OMMIC document "OM-CI-MV/ 001/ PG" contains more information on the precautions to take.

PACKAGE OUTLINE

Type	Description	Terminals	Pitch (mm)	Package size (mm)
QFN	Quad Flat No lead with exposed heat sink	28	0.5	4 x 5 x 0.85

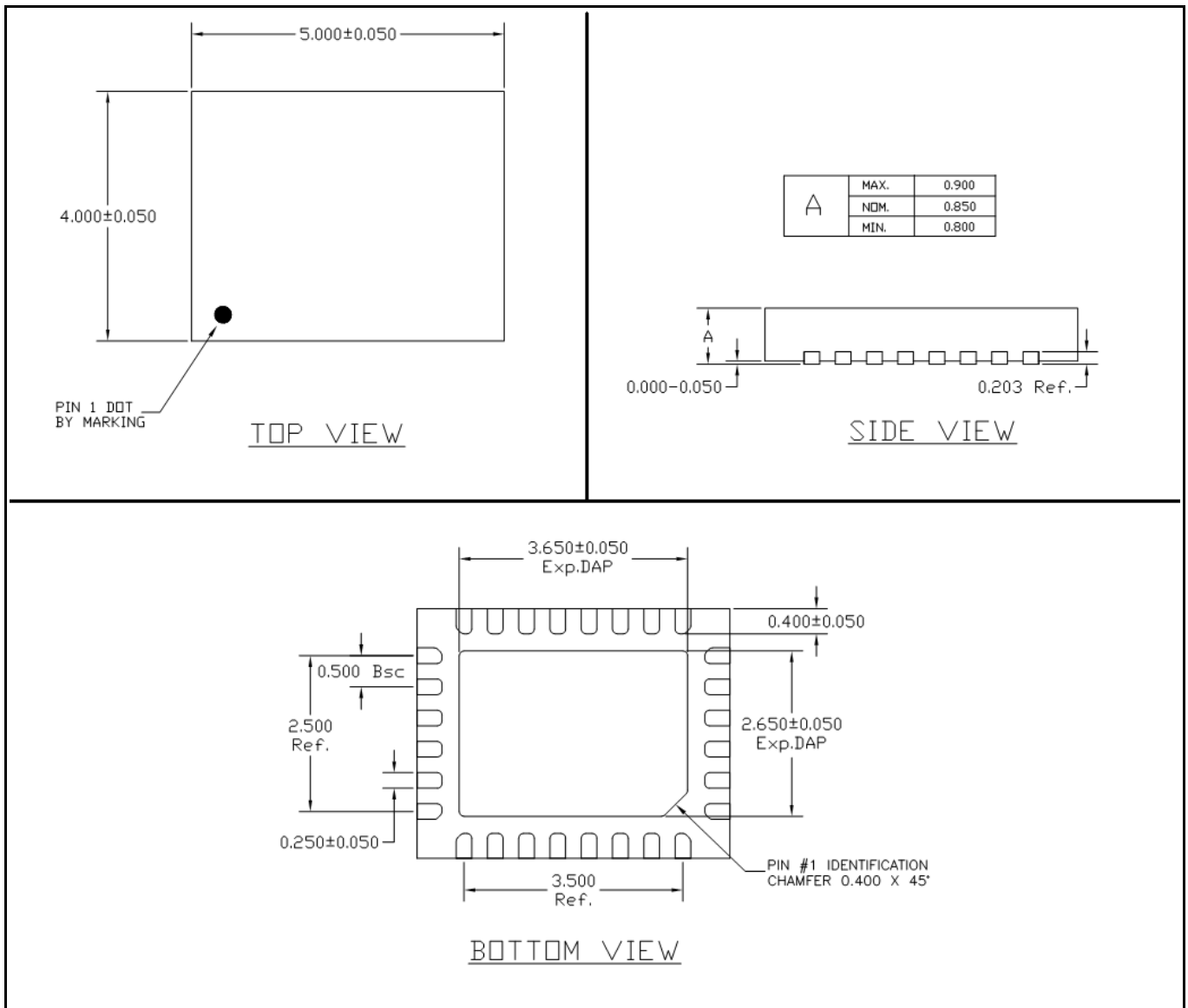

DEFINITIONS
Limiting values definition

Limiting values given are in accordance with the Absolute Maximum Rating System (IEC 60134). Stress above one or more of the limiting values may cause permanent damage to the device. These are stress ratings only and operation of the device at these or at any other conditions above those given in the Characteristics sections of the specification is not implied. Exposure to limiting values for extended periods may affect device reliability.

Application information

Applications that are described herein for any of these products are for illustrative purposes only. OMMIC makes no representation or warranty that such applications will be suitable for the specified use without further testing or modification.

DISCLAIMERS
Life support applications

These products are not designed for use in life support appliances, devices, or systems where malfunction of these products can reasonably be expected to result in personal injury. OMMIC's customers using or selling these products for use in such applications do so at their own risk and agree to fully indemnify OMMIC for any damages resulting from such application.

Right to make changes

OMMIC reserves the right to make changes, without notice, in the products, including circuits, standard cells, and/or software, described or contained herein in order to improve design and/or performance. OMMIC assumes no responsibility or liability for the use of any of these products, conveys no licence or title under any patent, copyright, or mask work right to these products, and makes no representations or warranties that these products are free from patent, copyright, or mask work right infringement, unless otherwise specified.

ORDERING INFORMATION

Generic type	Package type	Version	Sort Type	Description
CGY2179HV	QFN			4-bit Ku-band Core Chip
CGY2179UH	Bare Die			4-bit Ku-band Core Chip

Document History : Version 1.0, Last Update 20/05/2011