

PRELIMINARY DATASHEET

CGY2221HV/C1

X-Band 7.5-13 GHz Low Noise Amplifier

DESCRIPTION

The CGY2221HV/C1 is a high performance GaAs single supply Low Noise Amplifier MMIC designed to operate in the X band with an extremely high maximum input RF power.

The CGY2221HV/C1 has a low noise figure of 1.6 dB with minimum 16 dB of Gain. The on chip matching provides better than 12 dB of Input and Output Return Loss. It can be used in Radar, Telecommunication and Instrumentation applications.

The die is manufactured using OMMIC's 0.13 μm gate length PHEMT Technology. The MMIC uses gold bonding pads and backside metallization and is fully protected with Silicon Nitride passivation to obtain the highest level of reliability.

This technology has been evaluated for Space applications and is on the European Preferred Parts List of the European Space Agency. The device is available in a 4x4 mm² 24 leads QFN package.

APPLICATIONS

- Radar
- Telecommunications
- Instrumentation

FEATURES

- ▶ Operating Range : 7.5 GHz to 13 GHz
- ▶ Single supply architecture
- ▶ Noise Figure : 1.6 dB
- ▶ Gain > 16 dB
- ▶ Maximum input power: 31dBm
- ▶ Gain Flatness : +/- 0.8dB
- ▶ Output P_{1dB}: 17 dBm
- ▶ TOI: 29dBm
- ▶ Input Return Loss : 12 dB
- ▶ Output Return Loss : 15 dB
- ▶ Power supply : 82 mA @ 5 V
- ▶ 4x4 mm² 24 leads QFN Package
- ▶ Demonstration boards available

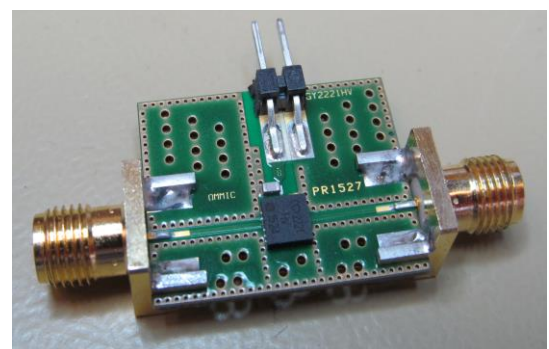

Demonstration board



MAXIMUM VALUES

 $T_{amb} = + 25 \text{ }^{\circ}\text{C}$

Symbol	Parameter	Conditions	MIN.	MAX.	UNIT
V_{dd}	Drain voltage		0	+ 6	V
I_{dd}	Drain current			100	mA
P_{IN}	RF Input power	CW / 10% Duty cycle 10us pulse		+21/+31	dBm
T_{amb}	Ambient temperature		- 55	+ 85	$^{\circ}\text{C}$
T_j	Junction temperature			+ 150	$^{\circ}\text{C}$
T_{stg}	Storage temperature		- 55	+ 150	$^{\circ}\text{C}$

Operation of this device outside the parameter ranges given above may cause permanent damage

THERMAL CHARACTERISTICS

Symbol	Parameter	Value	UNIT
$R_{th(j-amb)}$	Thermal resistance from junction to ambient (DC power at T_{amb} max)	TBD	$^{\circ}\text{C/W}$

ELECTRICAL CHARACTERISTICS

 $T_{amb} = + 25 \text{ }^{\circ}\text{C}$, $V_{dd} = 5\text{V}$

Symbol	Parameter	Conditions	MIN.	TYP.	MAX.	UNIT
R_{Fin}	Input frequency		8		12	GHz
<i>Performances of the package</i>						
V_{DD}	Drain Supply Voltage			+ 5		V
I_{DD}	Drain Supply Current		72	82	92	mA
G	Gain		16	17		dB
NF	Noise Figure		1.5	1.6	1.8	dB
P_{1dB}^*	1dB compression point		16	17		dBm
TOI	3 rd Order intercept (F=10Ghz, Pout=0dBm)			29		dBm
ISO_{rev}	Reverse Isolation	RF_{OUT}/RF_{IN}		-35	-30	dB
S_{11}	Input reflection coefficient	50 Ohms		-12		dB
S_{22}	Output reflection coefficient	50 Ohms		-15		dB

(*) Measurement reference planes are the INPUT and OUTPUT plans of the CGY2221HV/C1



Caution : This device is a high performance RF component and can be damaged by inappropriate handling. Standard ESD precautions should be followed. OMMIC document "OM-CI-MV/ 001/ PG" contains more information on the precautions to take.

ON BOARD MEASUREMENTS - S-PARAMETERS, NF, P1DB:

Measured at 25°C, VDD = 5V and ID = 82mA.

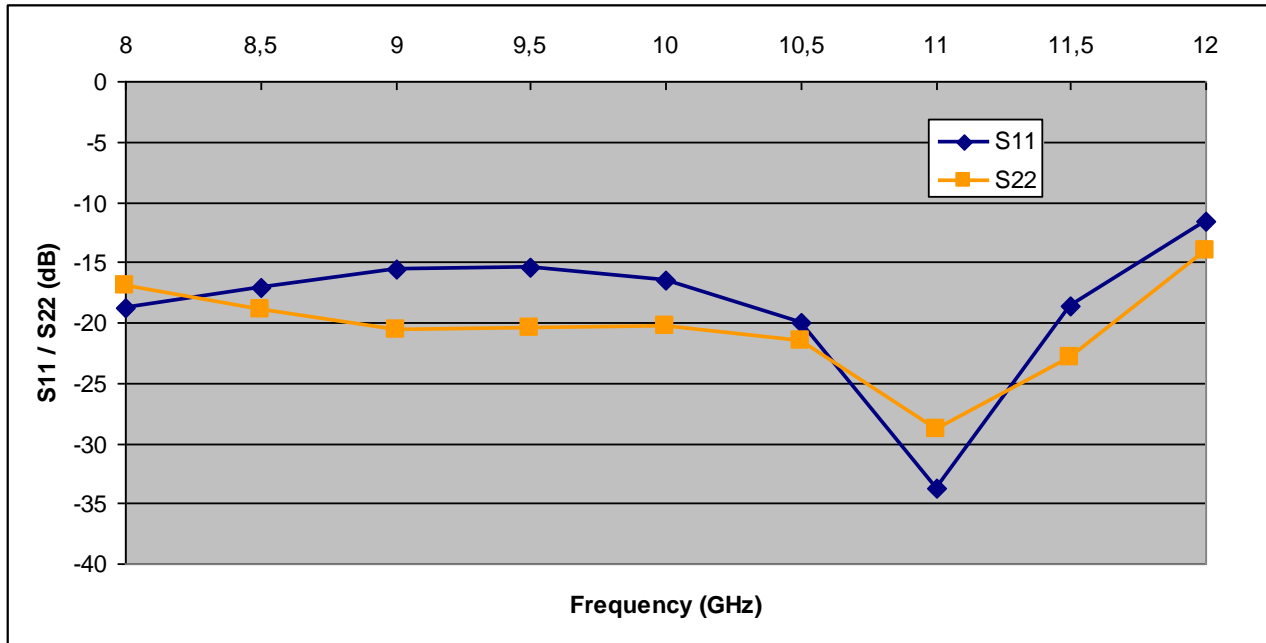

Gain measured at 25°C on board, WRT VDD.

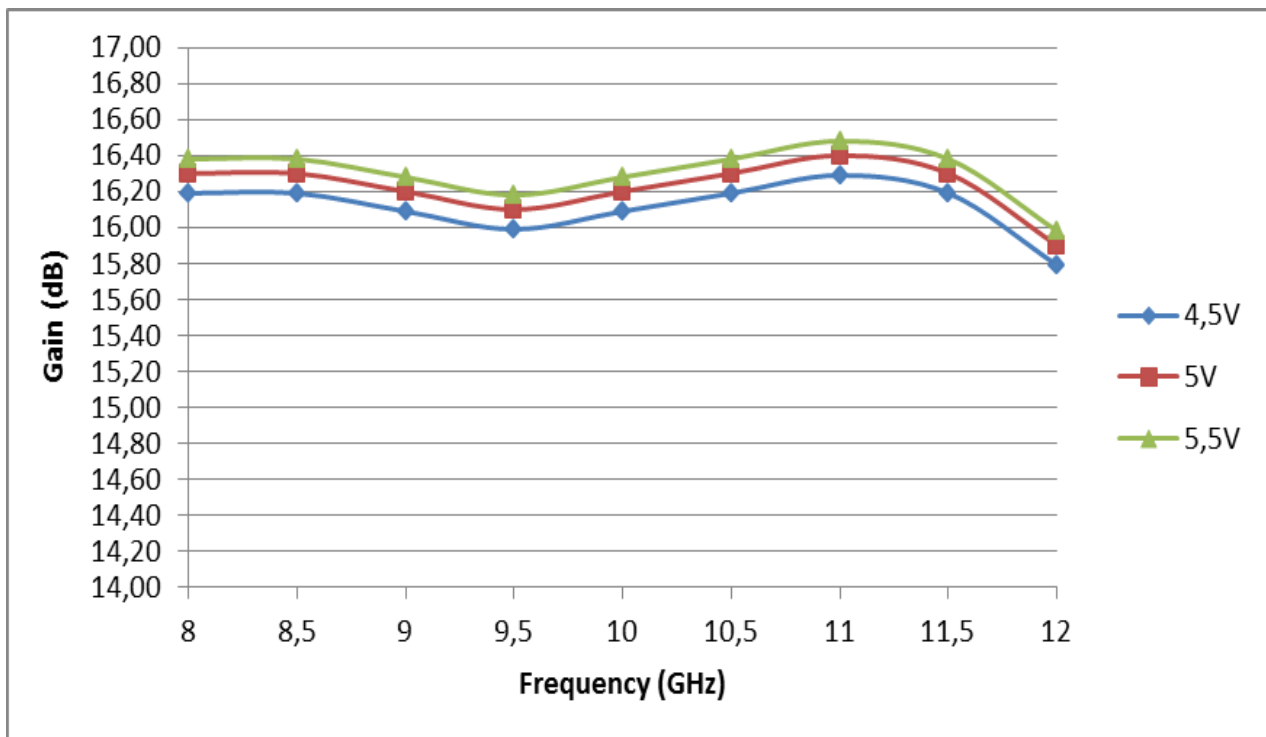

Noise Figure measured at 25°C on board, WRT VDD.

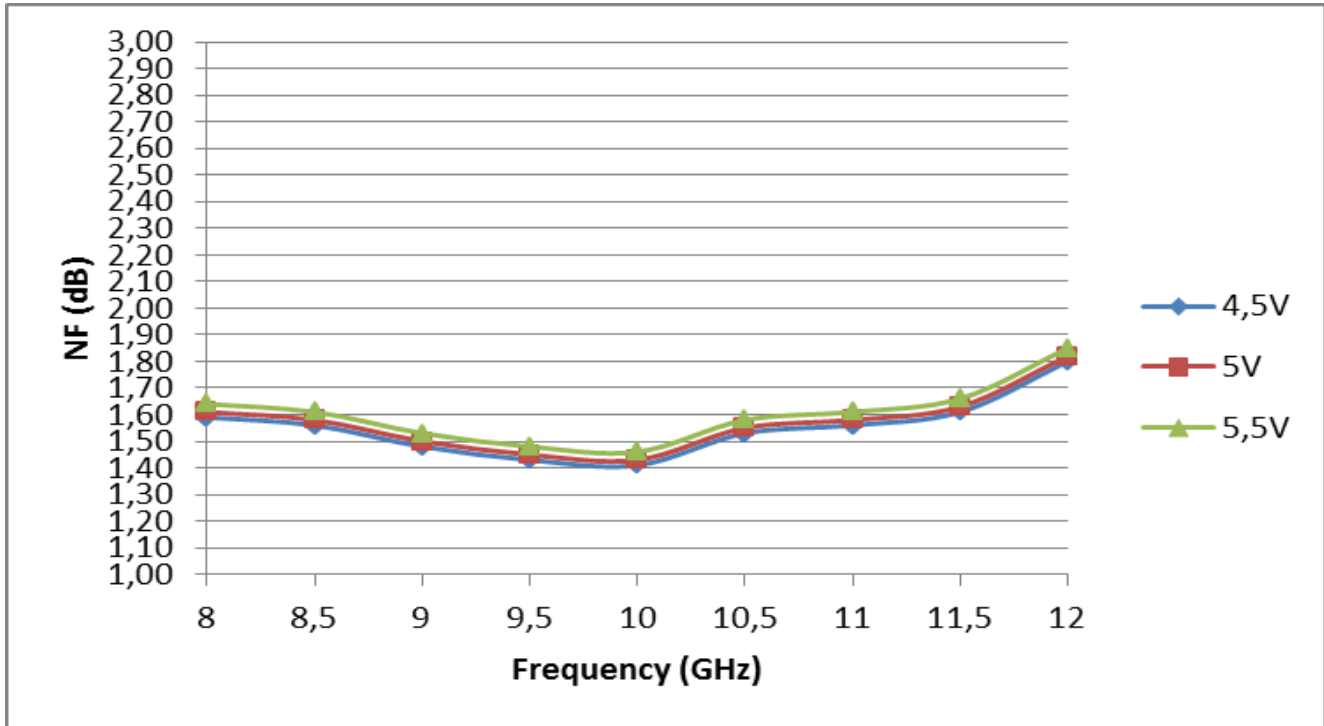

Gain vs. Temperature VDD = 5V ID = 82mA : Measured on Board

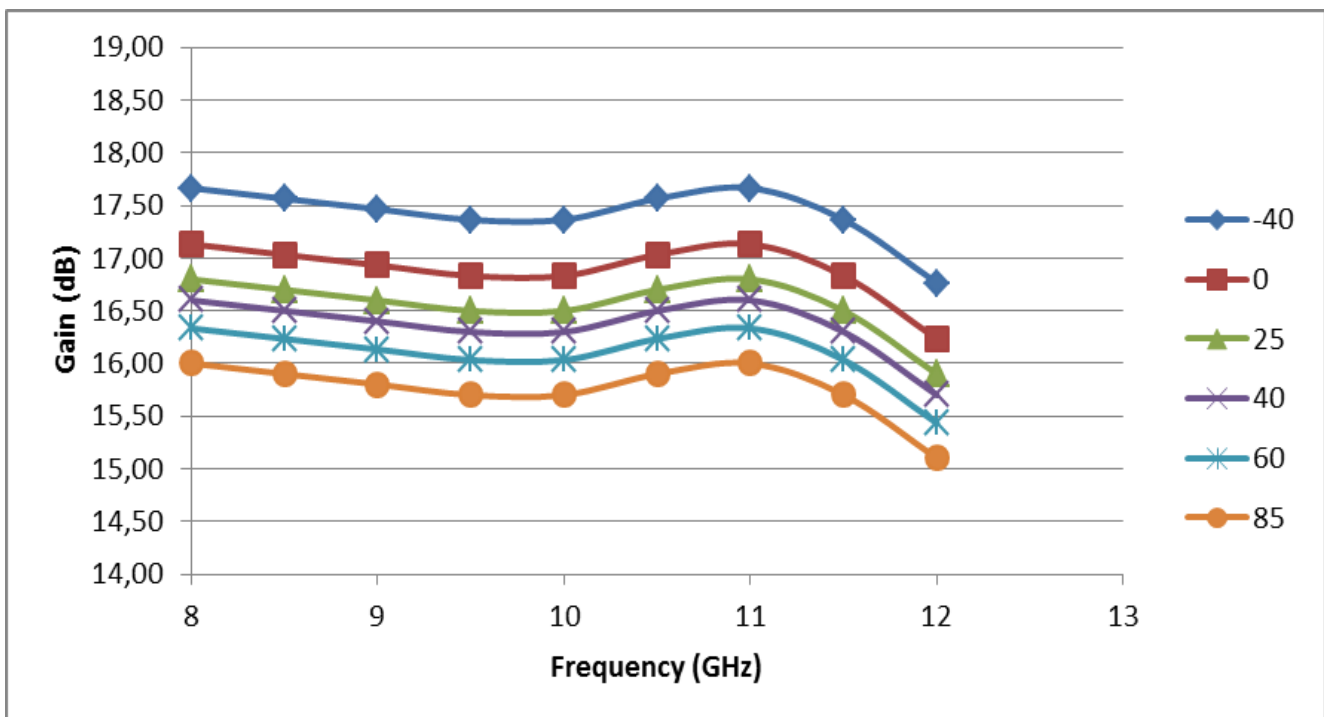

NF vs. Temperature: Measured on Board

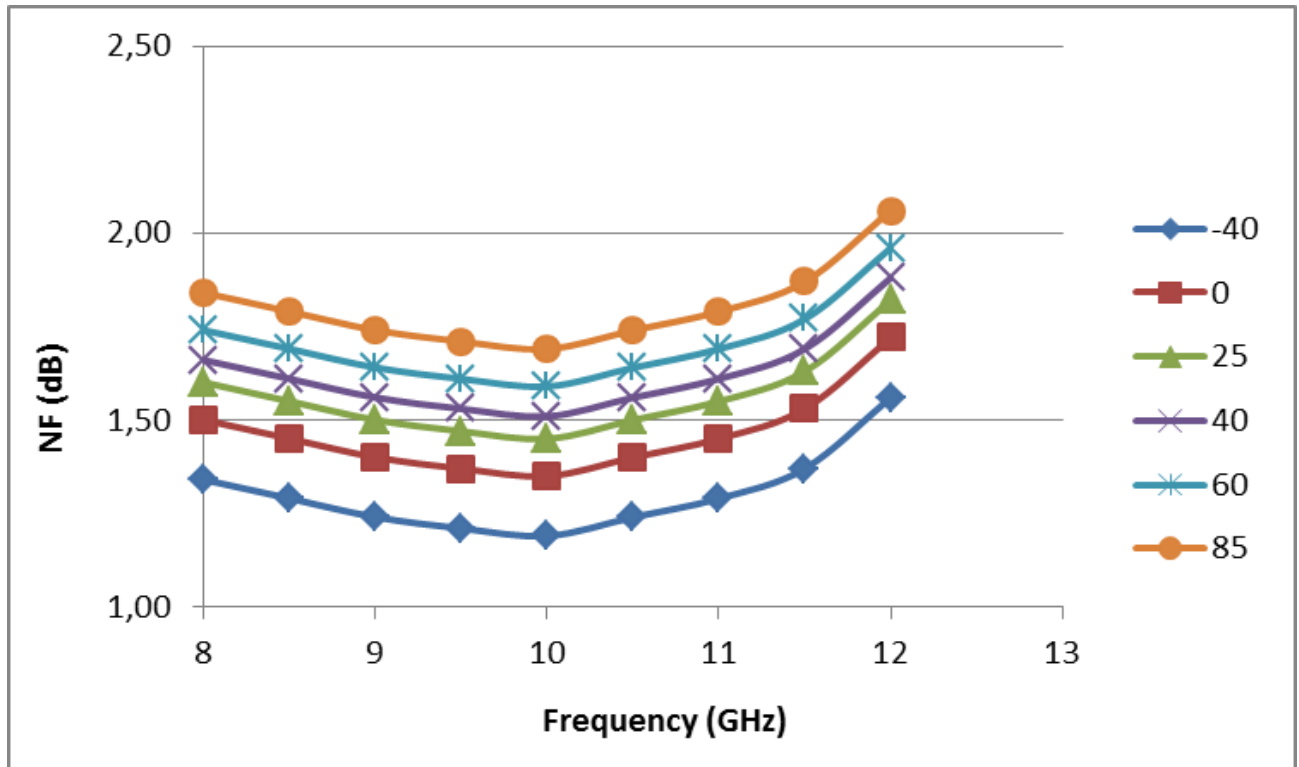

Output Power: Measured on Board

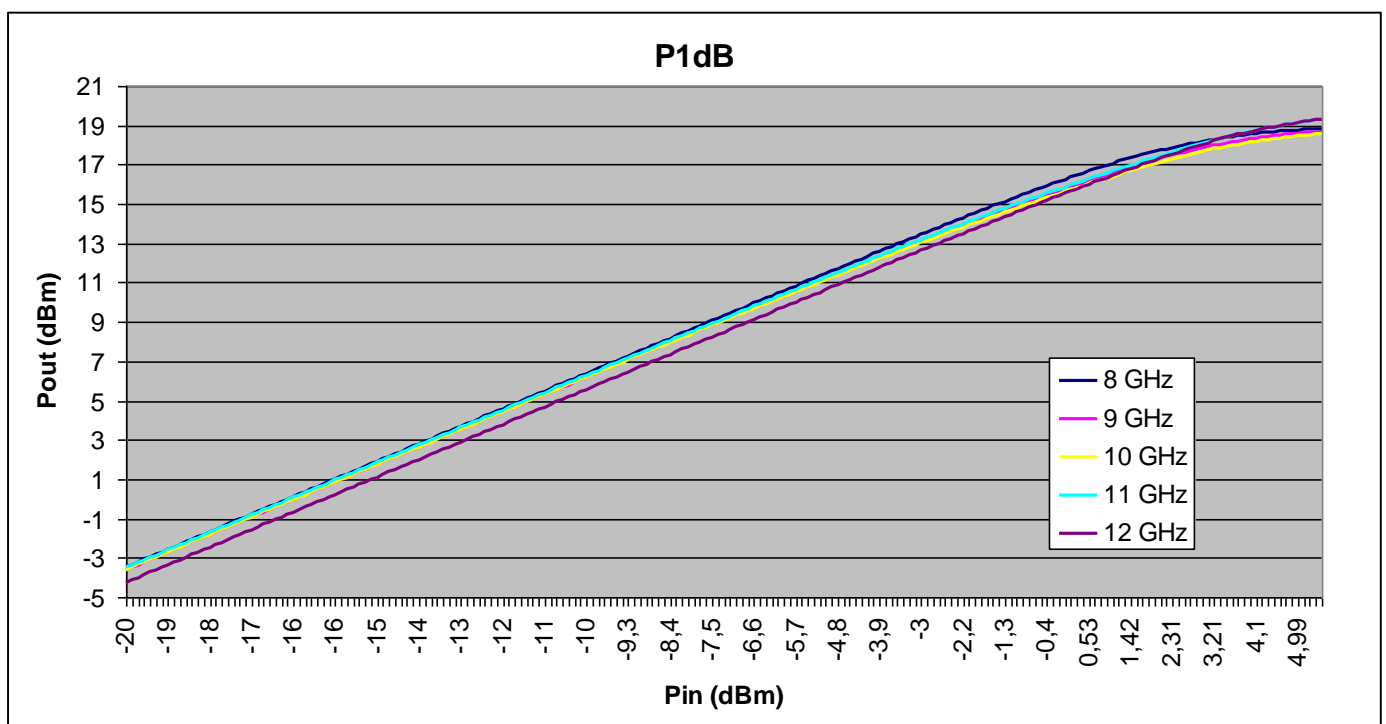

APPLICATION SCHEMATIC

To prevent instability of the customer design it is highly recommended to place small chip capacitors as near as possible to the CGY2221HV/C1, here 100pF recommended as placed in the demonstration board. Additionally, a 10nF capacitor can be added on a drain connection to insure low frequency decoupling, the power supply decoupling could be complemented with 1 uF capacitors.

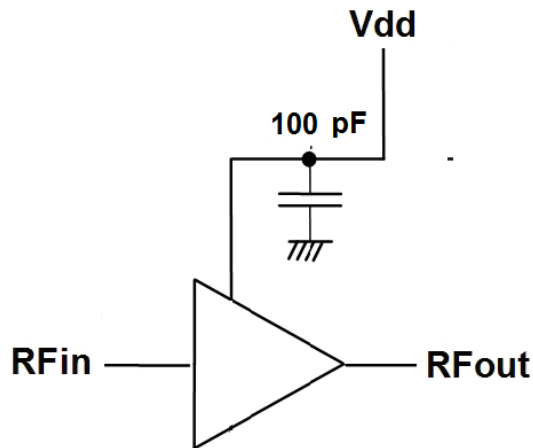
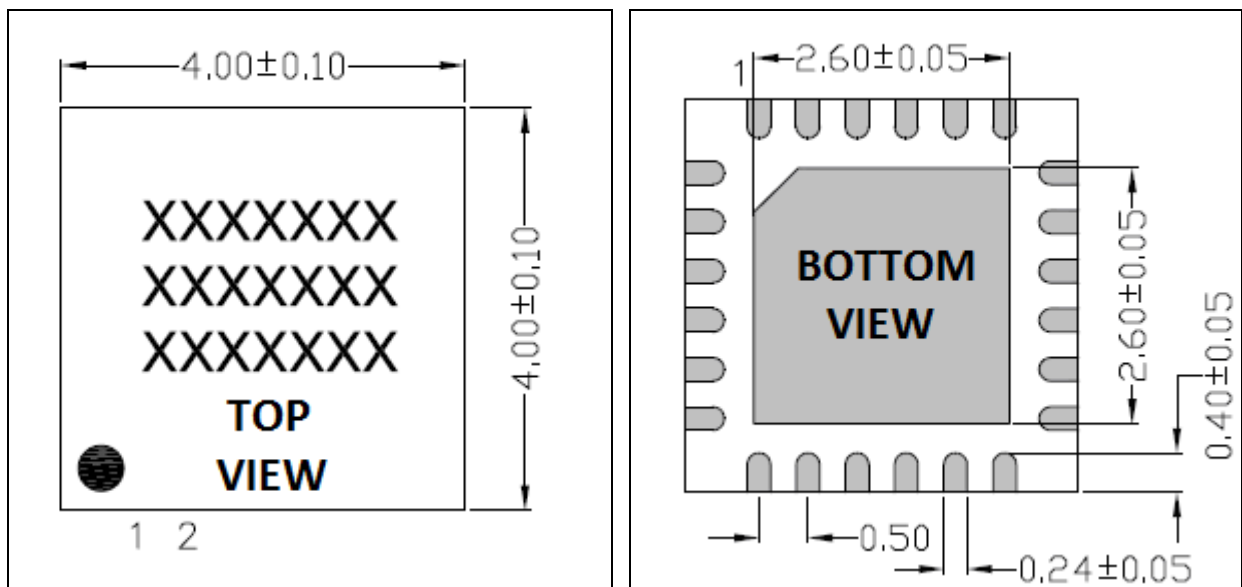

Figure 1 : Application schematics

PIN CONFIGURATION:



PINOUT

Symbol	PIN	Description
RFIN	3	RF input
RFOUT	16	RF output
GND	1,2,4,5,6,7,8,9,10,11,12,13,14,15,17, 18,19,20,22,23,24	Ground
VDD	21	Single Supply Voltage

Note :

It is essential In order to ensure good performance and stability that the central ground pad of the QFN package is suitably connected to the ground.

ORDERING INFORMATION

Generic type	Package type	Version	Description
CGY2221HV/C1	4x4mm ² 24L QFN	C1	X-band LNA



PACKAGE OUTLINE

Type	Description	Terminals	Pitch (mm)	Package size (mm)
QFN	Quad Flat No Leads with exposed heat sin	24	0.5	4 x 4 x 0.9

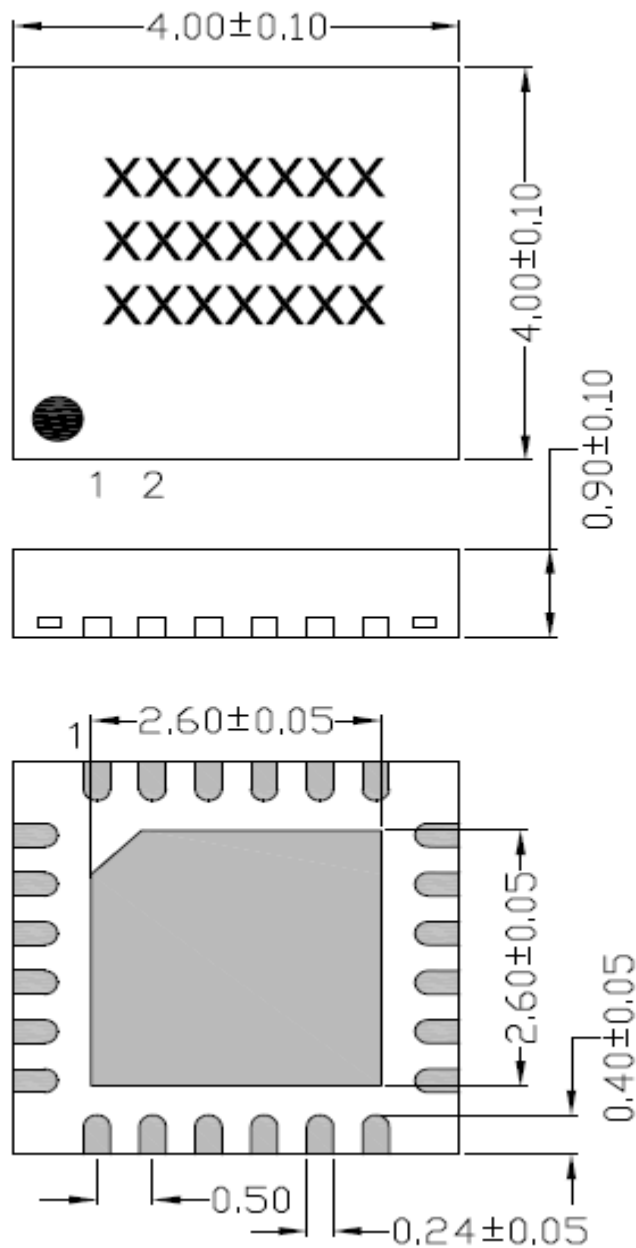

DEFINITIONS

Limiting values definition

Limiting values given are in accordance with the Absolute Maximum Rating System (IEC 60134). Stress above one or more of the limiting values may cause permanent damage to the device. These are stress ratings only and operation of the device at these or at any other conditions above those given in the Characteristics sections of the specification is not implied. Exposure to limiting values for extended periods may affect device reliability.

Application information

Applications that are described herein for any of these products are for illustrative purposes only. OMMIC makes no representation or warranty that such applications will be suitable for the specified use without further testing or modification.

DISCLAIMERS

Life support applications

These products are not designed for use in life support appliances, devices, or systems where malfunction of these products can reasonably be expected to result in personal injury. OMMIC's customers using or selling these products for use in such applications do so at their own risk and agree to fully indemnify OMMIC for any damages resulting from such application.

Right to make changes

OMMIC reserves the right to make changes, without notice, in the products, including circuits, standard cells, and/or software, described or contained herein in order to improve design and/or performance. OMMIC assumes no responsibility or liability for the use of any of these products, conveys no licence or title under any patent, copyright, or mask work right to these products, and makes no representations or warranties that these products are free from patent, copyright, or mask work right infringement, unless otherwise specified.